

SONARANGE

UPF-A 09.11 e

Ultrasonic fork sensors for web guide and edge control UPF-A Series

- Ultrasonic fork barrier with analogue output 0...10V
- The analogue signal is a function of lateral covering
- For edge control and web guidance systems
- For transparent foils
- For contaminated air
- High accuracy and temperature stability
- High measurement range
- Very small plane change influence
- high sampling rate
- teach-in
- Swiss made

New!
with teach-in



Technical data		UPF-A 30/8 TOR 24 CA	UPF-A 60/8 TOR 24 CA	UPF-A 40/13 TOR 24 CA	UPF-A 70/13 TOR 24 CA
Fork width	mm	30	60	40	70
Detection width	mm		~8 (±4)		~13 (±6.5)
Resolution (noise):					
- @ 20...80% covered	mm			approx. 0.1	
- @ 0...100% covered	mm			approx. 0.15	
Plane change (influence of position between transmitter T and receiver R):					
- <7mm off T or R	mm				≤ ±0.5
- >7mm off T or R	mm				≤ ±0.1
- <5mm off T or R	mm		≤ ±0.3		
- >5mm off T or R	mm		≤ ±0.1		
Linearity @ 10...90% covered (typical)	%FS		≤ 2		≤ 4
Ultrasonic frequency	kHz		approx. 180		approx. 130
Sampling frequency (in non synchronized mode)	Hz		500		285
Output signal	V			0...10	
Temperature stability 0...60°C (typical)	%			±5	
Power supply voltage (polarity reversal protection)	VDC			8...30	
Ripple of supply voltage	%			10	
Current consumption @ 24VDC	mA			35	
Power consumption	W			0.9	
Power indicator	-			3 LED yellow/green/yellow in keyboard	
Ambient temperature during operation	°C			0...+60	
Storage temperature	°C			-10...+70	
Synchronization input (connector pin 2)					
- square wave signal (on rising edge)	V		3.5 ... 30		3.5 ... 30
- min. signal duration	ms		0.02		0.02
- max. sampling frequency (for proper signal)	Hz		500		285
Max. cable length	m			20	
Protection class	-			IP67	
Housing material	-			black anodized aluminum	

www.datadetector.de

SONARANGE

UPF-A 09.11 e

Electrical connection	-		M12 connector, 4-pin	
Mass	g	200	220	360
				400

Properties

The edge sensors type UPF-A are based on the experience of SNT Sensortechnik AG with ultrasonic through beam sensors. New software algorithms and a unique **SONARANGE** ultrasonic transducer material allow an accuracy and temperature stability so far only realized with optical systems. But the ultrasonic fork barrier is much less sensitive to dirt and dust compared to optical sensors. Further more transparent materials such as foils can be perfectly handled.

The 5 advantages of SNT ultrasonic fork sensors

1. The SNT ultrasonic transducers have a large diameter.
Result: large measurement range combined with high linearity and resolution.
2. The all new **SONARANGE** material of the ultrasonic transducers has a Young's modulus which is constant up to higher temperatures compared to the past.
Result: high temperature stability.
3. The signals are compensated with computed data as well as with a temperature sensor.
Result: precise operation up to 60°C.
4. The sensors have the teach-in feature.
Result: They can be adapted to the actual air condition and the material.
5. Software and transducers are designed to eliminate the influence of multiple echoes.
Result: Very small influence of plane change and high measuring speed.

The UPF-A are ultrasonic through beam sensors with separated transmitter and receiver. They are suited for edge detection on web guiding systems. In contrast to conventional barriers they do not offer a simple on/off output signal, but they measure the degree of covering of the ultrasonic receiver as an analogue output signal. If the receiver is fully covered, the output is 0V and if not covered at all 10V or vice versa.

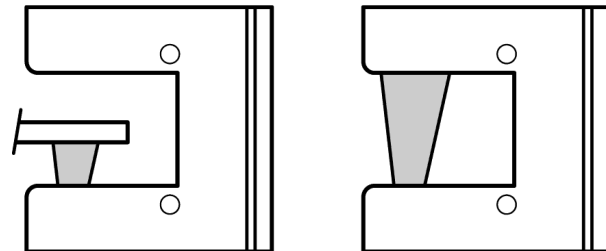

Status A: 0V
(or 10V inverted)

Status B: 10V
(or 0V inverted)

The relative humidity of air and the air pressure as well (sea level) have an influence on the output signal due to physical laws (attenuation of sound). Higher air humidity or decreasing air pressure do reduce the output signal at a given edge position.

- Sea level: for 100m higher sea level approx. 1.6% signal reduction
- Air pressure: for 10mbar pressure increase approx. 1.3% signal increase
- Air humidity: for 10% higher rel. air humidity approx. 1.2% signal reduction

The sensor can ideally be adjusted to the actual air conditions by the help of the teach-in function.

Teach-In

With teach-in the signal output can be defined at fully closed fork (status A) as well as at fully open fork (status B).

- Status A: If an acoustically non transparent material is in the fork, no signal is recorded by the receiver and thus the sensor shows 0V. However if the material is partly acoustically transparent (e.g. textiles), the sensor would show an offset. By teaching this status the offset can be eliminated and the full 10V span is available. For teaching the status A the material must be fully introduced into the fork.
- Status B: If nothing is between transmitter and receiver, the sensor should show the full signal of 10V. As explained above, the signal can slightly vary depending on air conditions. By teaching this status the full range signal can be adjusted to exactly 10V. For teaching the status B the fork must be fully free of material.

In addition, the output signal can also be inverted via teach-in, i.e. either rising or falling signal with increasing coverage of the sensor.

SONARANGE

UPF-A 09.11 e

Teach-In with keyboard

- Status A (material is fully introduced): push key A for min. 2s until yellow LED near A blinks 3x (acknowledgment by lighting of all 3 LEDs)
- Status B (no material in fork): push key B for min. 2s until yellow LED near B blinks 3x (acknowledgment by lighting of all 3 LEDs)
- Inverting the signal: push both keys A and B simultaneously for min. 5s until yellow LED near A lights up. Then release keys. Acknowledgment by lighting of all 3 LEDs. Reverse the inverting by the same procedure.
- Factory reset: push both keys A and B simultaneously for 10s until green LED lights up. Then release keys. Acknowledgment by lighting of all 3 LEDs.
- Key lock: push both keys A and B simultaneously for 15s until yellow LED near B lights up. Then release keys. Acknowledgment by lighting of all 3 LEDs. Unlock the keys in the same way.

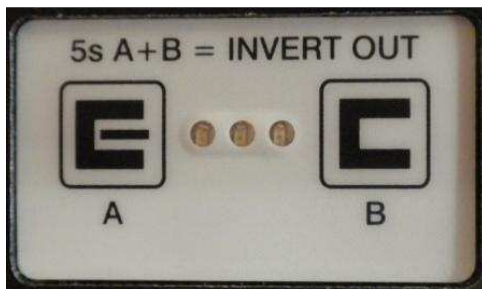

Teach-In by the connector

Pin 4 of the connector has besides the function for synchronization also the same teach function as Key B. The adjustment of the max. signal output at fully open fork can therefore also be done by connecting pin 4 with power supply voltage (nom. 24VDC) during min. 2s. Subsequently, the pin 4 must be removed from the tension.

The sensor can e.g. be operated after teaching with a 3 wire cable as well. Teach via connector is possible also if the key lock is enabled.

Synchronization

The internal sampling clock of the sensor can be overcome with an external repeating signal. This can be helpful if several sensors are measuring along a fast moving web.

Application

Measurement of the web edge position:

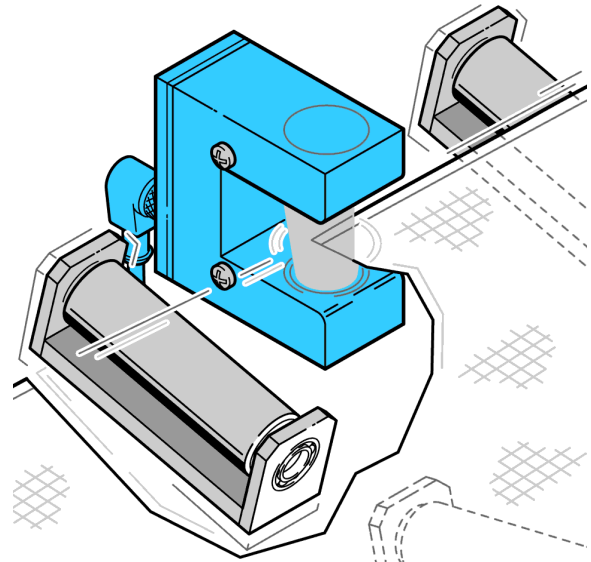

Various fork widths:

Larger fork widths are of particular interest if the material web is vertically heavily fluttering or if it does not always pass at the same position during unroll or roll up (see picture below).

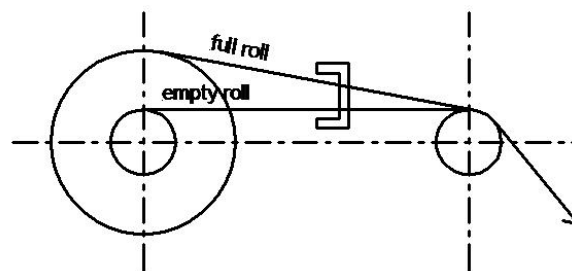

SONARANGE

UPF-A 09.11 e

Dimensions

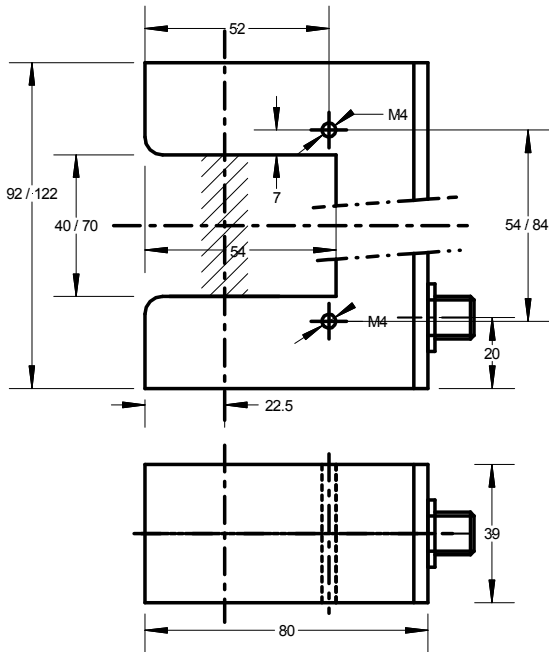

UPF-A 40/13 TOR 24 CA / UPF-A 70/13 TOR 24 CA

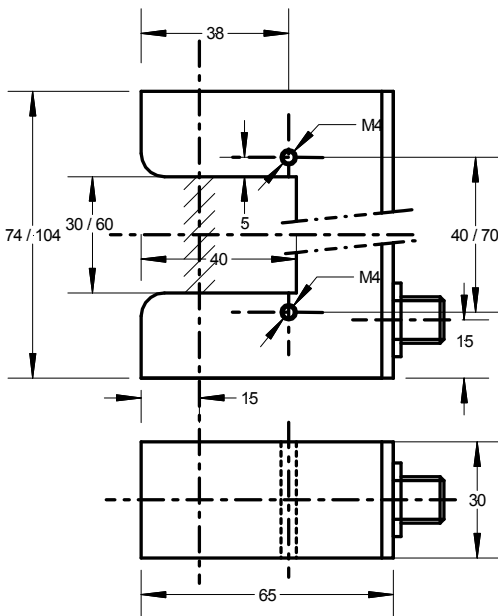

UPF-A 30/8 TOR 24 CA / UPF-A 60/8 TOR 24 CA

Electrical connection

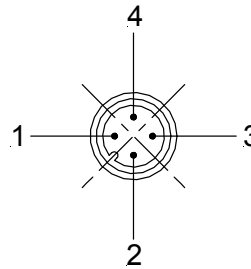

View on the sensor

- 1 brown: +24VDC
- 2 white: synchronization / teach-in input
- 3 blue: 0V
- 4 black: analogue output 0...10V

In case of heavy electromagnetic interference on the machine it can be advantageous to mount the sensor galvanically isolated (e.g. plastic liner and plastic screws). Furthermore the machine chassis can be connected to the sensor ground (0V).

Accessories (see also data sheet ,ACC')

PUR cable 3-wire (pin 1, 3, 4) with M12 connector:
l=2m Type KAB 2L3VGPUR

PUR cable 4-wire with M12 connector:
l=2m Type KAB 2L4VGPUR

