

## Ultrasonic distance and proximity sensors UPR-A Series

- Measuring distances from 120mm to 1500mm
- Analogue or binary output
- Configurable beam size
- Teach-In
- To be configured as scanner or retroreflective barrier
- Watertight, IP 67, oil resistant, robust
- Measurement independent of material, surface, colour and size of target
- Work under dust, dirt, fog, light
- Detect transparent and bright objects
- Swiss made



**programmable!**

### Technical data

		UPR-A 1500 TOR 24 C(W)AI	UPR-A 1500 TVPA 24 C(W)
Detection range	mm	120...1500	
Blind range (no reasonable analogue signal)	mm	0...120	
Hysteresis of binary output, axial	mm	-	2
Resolution	mm	~0.5	
Linearity	%FS	<1	-
Over all accuracy in whole temperature range *)	%FS		<2
Operating frequency	kHz		~180
Status indicator	-		LED yellow/red
Binary output, short circuit proof, max. 0.1A	-	-	PNP NO/NC
Switching speed max.	Hz	-	~5
Speed of analogue output	Hz	~30	-
Analogue output			
R <sub>L</sub> min. 10kΩ with V output	V	0...10V	-
R <sub>L</sub> max. 400Ω with mA output	mA	4...20mA	-
Power supply voltage (reversal polarity protection)	VDC		11...30
Ripple of supply voltage	%		10
Mean consumption	mA	~45...65	~45
Temperature range	°C		0...+60
Pressure range	mbar <sub>abs</sub>		900...1100
Mass	g		~65
Protection class	-		IP67
Housing material	-		nickel plated brass
Electrical connection	-		M12 connector 4-pin

\*) The accuracy can be improved beyond by teaching the sensor only after it has reached its thermally stable state (e.g. after 30 minutes).

### Versions

	axial sensing direction	radial sensing direction
Analogue output 0...10V and 4...20mA	UPR-A 1500 TOR 24 CAI	UPR-A 1500 TOR 24 CWAII
Binary output PNP	UPR-A 1500 TVPA 24 C	UPR-A 1500 TVPA 24 CW
Option: Binary output NPN instead of PNP	UPR-A 1500 TVNA 24 C	UPR-A 1500 TVNA 24 CW

[www.datatetector.de](http://www.datatetector.de)

This Information corresponds to the current state of knowledge. SNT reserves the right to make technical changes. Do not use these products in any application where failure of the product could result in personal injury. Liability for consequential damage resulting from the use of SNT products is excluded.

Datatetector a Datasensor Business Unit, Tegernseerstr. 75, D-83629 Otterfing, Phone +49 (0) 8024 90 277-0, Fax +49 (0) 8024 90 277-0, info@datatetector.de

## Description

The compact ultrasonic sensors of the UPR-A series are characterized by a wide range of max. 1.5m. Furthermore they are configurable by the user. Thanks to three different sized detection lobes, the sensor can be adapted locally to the application.

The sensor is available as a pure proximity switch as well as a distance sensor with analog output. Suitable applications include object detection as well as distance and level measurement.

The switching and analogue outputs can be taught by the user (rising/falling or NC/NO or window). The binary type is also programmable as a reflective barrier. This is useful when badly to detect objects stay in front of a background. The analogue sensor automatically detects the connected load, and exits accordingly mA or V. Programming is done using a single teach input. Optionally a teach-in box is available.

Thanks to the new transducer sealing made of Viton® the UPR-A sensors are very robust against many environmental influences. In particular, they are oil resistant, unlike many other ultrasonic sensors.

## Choice of model

There is a version with binary and one with analogue output, and one each with axial and radial sensing direction.

### UPR-A 1500 TVPA 24 C(W)

Ultrasonic sensor with a binary output with 2 teachable switching points (NO, NC or window or retro-reflective function).

### UPR-A 1500 TOR 24 C(W)A

Ultrasonic sensor for distance measurement with an analogue output 0...10V or 4...20mA. Automatic detection of the connected load (measuring device). The lower and upper limits are teachable.

## Blind range

The lower detection range between 0...120mm is called blind range. It is typical for ultrasonic sensors. In the blind range no distance measurement is possible. However the pure function as proximity switch (binary output) is possible in the blind range with certain restrictions (only bigger objects).

## Setting the switching points in scanning mode

### **UPR-A 1500 TVPA 24 C(W)**

In scanning mode the target partially reflects the ultrasound which is then detected by the sensor. The switching points are set by connecting the teach input with either the power supply  $-U_B$  (0V) or  $+U_B$  (+24VDC) for 1...5s.

The blinking LED shows during teaching if the sensor has detected the object.

- LED blinks yellow: detected
- LED blinks red: not detected

### Window operation NO

- Place the object to the near switching point
- Teach 1...5s switching point with  $-U_B$
- Place the object to the far switching point
- Teach 1...5s switching point with  $+U_B$

### Window operation NC

- Place the object to the near switching point
- Teach 1...5s switching point with  $+U_B$
- Place the object to the far switching point
- Teach 1...5s switching point with  $-U_B$

### Switching point NO

- Place the object to the switching point
- Teach 1...5s switching point with  $+U_B$
- Let the sensor look into the void (>1.5m)
- Teach 1...5s with  $-U_B$

### Switching point NC

- Place the object to the switching point
- Teach 1...5s switching point with  $-U_B$
- Let the sensor look into the void (>1.5m)
- Teach 1...5s with  $+U_B$

## Setting the switching point in retroreflective mode

### **UPR-A 1500 TVPA 24 C(W)**

In retroreflective mode a reflector is used in the background of the scenery (max. 1.5m away from sensor). In contrast to optical sensors the reflector can be of any material, which is able to reflect the sound. Retroreflective mode is used instead of scanning mode when the target is in a small angle to the sensor beam (see below sketch) or when it is very sound absorbing, i.e. when not sufficient sound is reflected. In this mode the sensor permanently checks whether it sees the reflector or if it is covered by the target.

In retroreflective mode the reflector is taught as follows.

- NO: Teach 5...10s with  $+U_B$   
(yellow LED blinks fast)
- NC: Teach 10...15s with  $+U_B$   
(red LED blinks fast)

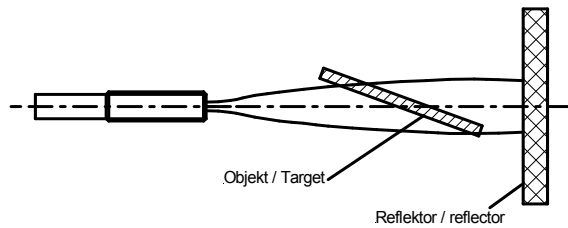

## Setting the measuring limits analogue output UPR-A 1500 TOR 24 C(W)AI

The two measuring limits are set by connecting the teach input with either the power supply  $-U_B$  (0V) or  $+U_B$  (+24VDC) for 1...5s. The blinking LED shows during teaching if the sensor has detected the object.

LED blinks yellow: detected

LED blinks red: not detected

With  $-U_B$  the lower measuring limit (0V or 4mA) and with  $+U_B$  the upper measuring limit (10V or 20mA) is taught. Thus it is possible to teach a rising or a falling ramp.

- Place the object at the lower measuring limit (i.e. where 0V or 4mA is expected)
- Teach 1...5s lower measuring limit with  $-U_B$
- Place the object to the upper measuring limit (i.e. where 10V or 20mA is expected)
- Teach 1...5s upper measuring limit with  $+U_B$

Lower and upper measuring limits can also later be programmed individually.

### Caution:

The teach wire must not be connected during normal operation. The sensor can e.g. be operated after teaching with a 3 wire cable.

## Electrical connections (view to the sensor)

UPR-A 1500 TVPA 24 C(W)

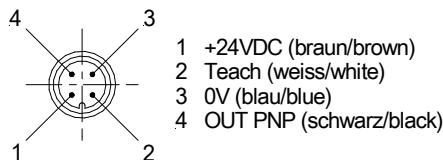

UPR-A 1500 TOR 24 C(W)AI

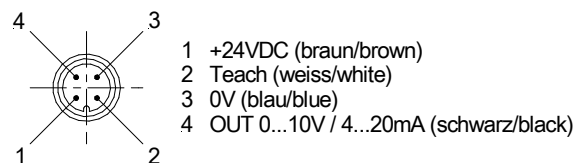

## Detection beam

The detection beam of an ultrasonic sensor has the shape of a cone. The size depends on the target and its sound reflecting characteristics. Small and more badly reflecting objects result in a smaller cone (narrower and shorter). Bigger objects and those with surfaces which are not perpendicular to the central axis can expand the cone. The exact cone shape and size can be determined only at the object itself. No disturbing objects must be between the sensor and the target within the cone. Otherwise the sensor would detect the disturbing object instead of the desired target. Beside the three typical cone shapes for the UPR-A sensors are shown (small, medium and large cone). Furthermore the size of the detection beam is influenced by air temperature and humidity. The colder and dryer the air, the larger is the beam.

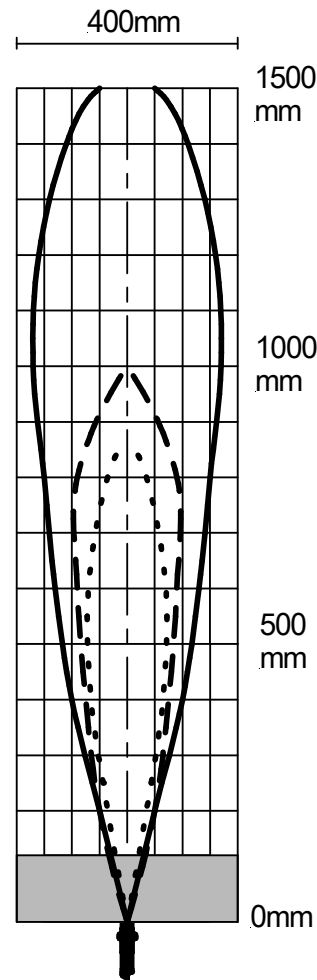

On UPR-A sensors three different cones can be programmed by the user. This is e.g. helpful when sensing into small containers or between narrow gaps.

The cone size is set by connecting the teach input for >5s with the power supply  $-U_B$  (0V):

- Small cone: Teach 5...10s with  $-U_B$  (yellow LED blinks fast)
- Medium cone: Teach 10...15s with  $-U_B$  (yellow/red LED blinks fast)
- Large cone: Teach 15...20s with  $-U_B$  (red LED blinks fast)

## Mounting

Ultrasonic sensors shall be mounted as soft as possible in order keep acoustic disturbances away from the mounting spot. Thus two M18 nuts, washers and rubber sleeves for mounting are included. The rubber sleeves for a hole of Ø21mm shall be used.

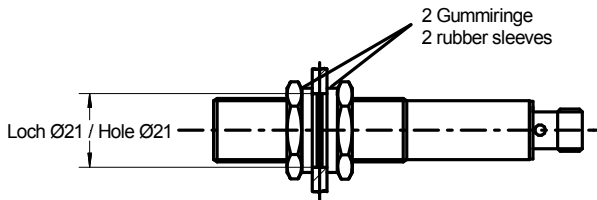

## Dimensions

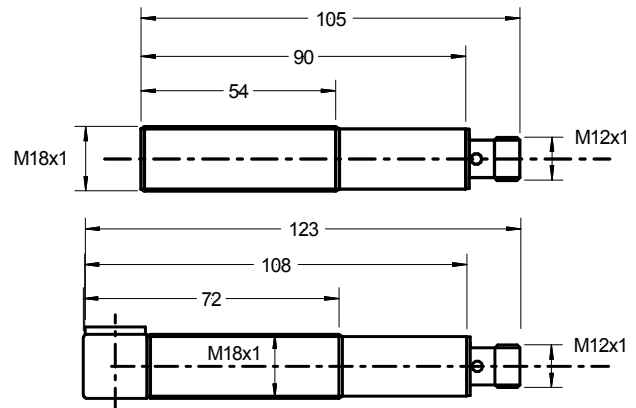

## Inclination angle of object

Smooth surfaces can be detected up to an inclination angle of 10°. However rough and structured (granular) surfaces can be detected up to much higher angles. In retroreflective mode the angle does not matter at all.

## Cable

The sensors have an M12 4-pin connector for screw mounting. The cable should not be mounted parallel or close to high current cables. Cables have to be ordered separately.

## Accessories (see also data sheet ,ACC')

PUR cable 3-wire (pin 1, 3, 4) with M12 connector:  
l=2m Type KAB 2L3VGPUR

PUR cable 4-wire with M12 connector:  
l=2m Type KAB 2L4VGPUR

PUR cable 4-wire with M12 connector:  
l=5m Type KAB 5L4VGPUR

Teach-In box: see separate data sheet

## Parts included

- Sensor
- 2 of each M18 nuts, washers and rubber sleeves for mounting

## Teach Table

Time	Connect teach wire with:	LED blinking	Version with binary output UPR-A 1500 TVPA 24 C(W)	Version with analogue output UPR-A 1500 TOR 24 C(W)AI
1...5s	+U <sub>B</sub> (typ. +24VDC)	yellow slowly	NO: far window point or switching point NC: near window point	10V or 20mA
1...5s	-U <sub>B</sub> (0VDC)	yellow slowly	NO: near window point NC: far window point or switching point	0V or 4mA
5...10s	+U <sub>B</sub> (typ. +24VDC)	yellow fast	retroreflective barrier NO	-
10...15s	+U <sub>B</sub> (typ. +24VDC)	red fast	retroreflective barrier NC	-
5...10s	-U <sub>B</sub> (0VDC)	yellow	small detection cone	small detection cone
10...15s	-U <sub>B</sub> (0VDC)	yellow/red	medium detection cone	medium detection cone
15...20s	-U <sub>B</sub> (0VDC)	red	large detection cone	large detection cone
>20s	-U <sub>B</sub> (0VDC)	no LED	factory reset	factory reset

## Ultrasonic distance and proximity sensors resistant against chemicals UPR-A CP Series

- based on UPR-A series
- CP means "Chemical Protection"
- resistant against most chemicals such as acids and alkalis
- front part made of PVDF
- Membrane protected with PTFE foil
- for level measurement and control of aggressive media



### Versions

Analogue output 0...10V and 4...20mA	UPR-A 1500 CP TOR 24 CAI
Binary output PNP	UPR-A 1500 CP TVPA 24 C
Binary output NPN	UPR-A 1500 CP TVNA 24 C

### Description

The UPR CP series sensors are specially designed for use in a chemically harsh environment. The high resistance is based on PVDF or PTFE material. A typical application is the level measurement of acids and alkalis in smaller containers. The basic sensor is a model UPR-A 1500. The front part exposed to the medium is made of PVDF. The outstanding feature is the ultrasonic transducer which is PTFE foil covered allowing the ultrasonic waves to pass. The technical data correspond to those of the UPR-A sensors (see page 1).

### Mounting

Mounting on the flange with 6 M4 screws or mounting on the G1" thread. Sealing with Viton O-rings which are included with the sensor.

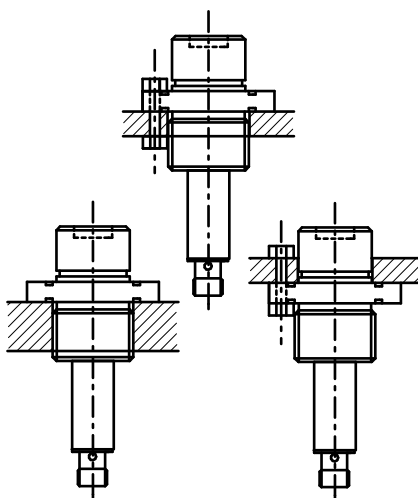

### Dimensions

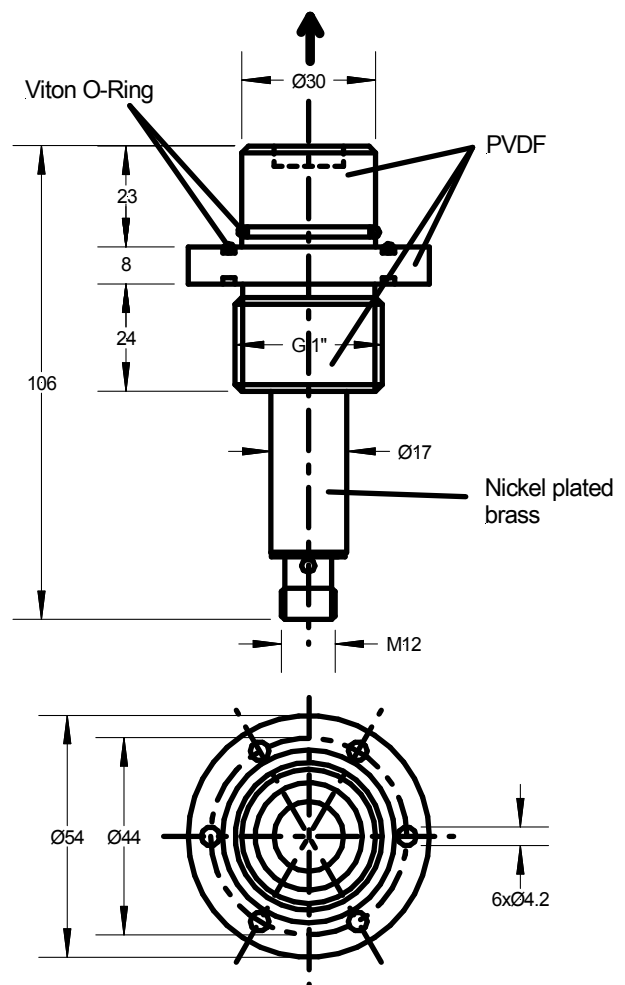

[www.datatetector.de](http://www.datatetector.de)