

SONARANGE

UPS 09.11 e

Miniature ultrasonic distance and proximity sensors UPS Series

- Measuring range up to 200mm
- Very small blind range
- Narrow detection beam
- Small size M12x1
- Teach-In
- Binary or analogue outputs
- Special versions with particularly narrow beam or chemically resistant
- Measurement independent of material, surface, colour and size of target
- Work under dust, dirt, fog, light
- Detect transparent and bright objects



Technical specifications UPS 200 ...

		UPS 200 TVPA 24 C	UPS 200 TOR 24 CA	UPS 200 TOR 24 CI
Detection and adjustment range	mm		20...200	
Blind range (no reasonable analogue output signal)	mm		20	
Hysteresis	%	≤1	-	-
Linearity of analogue output	%FS	-	<1	<1
Reproducibility	%FS	<0.5	<0.5	<0.5
Temperature error	%FS	≤1.5	≤1.5	≤1.5
Operating frequency	kHz		~400	
Status indicator	-		LED yellow/red	
Binary output, reversal polarity protection	-	PNP NO/NC max. 0.1A	-	-
Switching speed max.	Hz	13	-	-
t _{on} binary output	ms	~30	-	-
Analogue output in detection range				
R _L min. 1kΩ with V output	V		0...10	
R _L max. 300Ω with mA output	mA			4...20
Power supply (reversal polarity protection)	VDC	10...30	15...30	10...30
Power supply ripple	%		10	
Mean consumption, switched without load	mA		~30	
Ambient temperature during operation	°C		-25...+70	
Mass	g		25	
Protection class	-		IP65	
Housing material	-		nickel plated brass	
Electrical connection	-		connector M12, 4-pin	

Description

The ultrasonic sensors of the UPS series are particularly small, and they have a narrow detection beam. Thus they are well suited to detect objects in the near range up to 150 or 200mm and under confined conditions. The sensors are available as well as pure proximity switches as also as

distance sensors with analogue mA or V output. The switch or measuring distances can be learned by a teach-in procedure. An optional Teach-In box is available. Typical applications are detection of objects and distance and level measurement.

SONARANGE

UPS 09.11 e

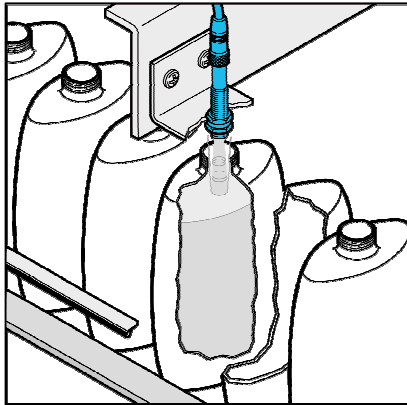

Model selection

The UPS versions have different outputs.

UPS ... TVPA 24 C

Ultrasonic sensor with a binary output with 2 teachable switching points (NO, NC or window function).

UPS ... TOR 24 CA

Ultrasonic sensor for distance measurement with an analogue output 0...10V. The lower and upper limits are teachable.

UPS ... TOR 24 CI

Ultrasonic sensor for distance measurement with an analogue output 4...20mA. The lower and upper limits are teachable.

Blind range

The lower detection range is called blind range. It is typical for ultrasonic sensors. In the blind range no distance measurement is possible! However the pure function as proximity switch (binary output) is possible in the blind range with certain restrictions (only bigger objects).

Setting of the switching points (UPS ... TVPA 24 C)

The switching points are set by connecting the teach wire with either the power supply $-U_B$ (0V) or $+U_B$ (+24VDC). The voltage must be active for min. 1s on the teach wire. The LED shows during teaching if the sensor has detected the object.

Window operation NO

- Place the object to the near switching point
- Teach switching point with $-U_B$
- Place the object to the far switching point
- Teach switching point with $+U_B$

Window operation NC

- Place the object to the near switching point
- Teach switching point with $+U_B$
- Place the object to the far switching point
- Teach switching point with $-U_B$

Switching point NO

- Place the object to the switching point
- Teach switching point with $+U_B$
- Cover the sensor diaphragm by hand or let the sensor look into the void
- Teach with $-U_B$

Switching point NC

- Place the object to the switching point
- Teach switching point with $-U_B$
- Cover the sensor diaphragm by hand or let the sensor look into the void
- Teach with $+U_B$

Application hint window operation (UPS ... TVPA 24 C)

In window operation the sensor detects only targets which are within the window limits. The same function can also be used to simulate a kind of retro-reflective sensor. The reflector is mounted in the small window between Teach A and Teach B (see drawing below). In such setup the sensor detects also targets which pass the sensor beam in a very flat angle. The sensor would not detect such targets in normal scan operation mode.

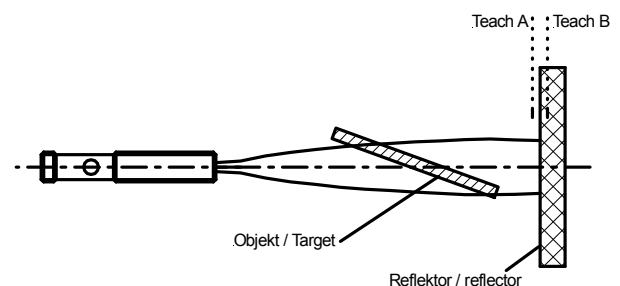

Setting the measuring limits (UPS ... TOR 24 CA/I)

The two measuring limits are set by connecting the teach wire with either the power supply $-U_B$ (0V) or $+U_B$ (+24VDC). The voltage must be active for min. 1s on the teach wire. The LED shows during teaching if the sensor has detected the object. With $-U_B$ the lower measuring limit (0V or 4mA) and with $+U_B$ the upper measuring limit (10V or 20mA) is taught. Thus it is possible to teach a rising or a falling ramp.

SONARANGE

UPS 09.11 e

- Place the object to the lower measuring limit (i.e. where 0V or 4mA is expected)
- Teach lower measuring limit with $-U_B$
- Place the object to the upper measuring limit (i.e. where 10V or 20mA is expected)
- Teach upper measuring limit with $+U_B$

Lower and upper measuring limits can also later be programmed individually. The teach wire must not be connected during normal operation. The sensor can e.g. be operated after teaching with a 3 wire cable.

LED indicator

	LED red	LED yellow
During teach-in:		
- object detected	off	blinking
- no object detected	blinking	off
- object not reliably detected	on	off
Normal operation PNP	off	switching status
Normal operation analogue	off	on
Error	on	last status

Mounting

The sensor can be mounted with the two M12 nuts (HEX 17) which are scope of delivery.

Inclination angle of object

Smooth surfaces can be detected up to an inclination angle of approx. 10° . However rough and structured (granular) surfaces can be detected up to much higher angles.

Cable

The sensors have an M12 4-pin connector for screw mounting. The cable should not be mounted parallel or close to high current cables. Cables have to be ordered separately.

Electrical connections (view to the sensor)

UPS ... TVPA 24 C

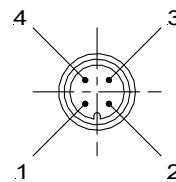

- 1 +24VDC (braun/brown)
- 2 Teach (weiss/white)
- 3 0V (blau/blue)
- 4 OUT PNP (schwarz/black)

UPS ... TOR 24 CA

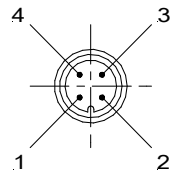

- 1 +24VDC (braun/brown)
- 2 Teach (weiss/white)
- 3 0V (blau/blue)
- 4 OUT 0...10V (schwarz/black)

UPS ... TOR 24 CI

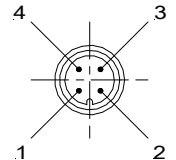

- 1 +24VDC (braun/brown)
- 2 Teach (weiss/white)
- 3 0V (blau/blue)
- 4 OUT 4...20mA (schwarz/black)

Special miniature ultrasonic distance and proximity sensors UPS FB und UPS CP Series

UPS 150 FB ...

- Very narrow detection beam (FOCUS Beam)
- Particularly for level measurement in narrow cavities
- No blind range
- Measuring range up to 150mm
- Teach-In
- Binary or analogue outputs

UPS 150 CP ...

- Chemically resistant version (PVDF)
- Diaphragm PTFE coated
- Front resistant to most chemicals
- Measuring range up to 150mm
- Teach-In
- Binary or analogue outputs

Technical data (rest same as UPS 200...)

UPS 150 FB ...

UPS 150 CP ...

Detection and adjustment range	mm	0...150	20...150
--------------------------------	----	---------	----------

SONARANGE

UPS 5.11 e

Description

UPS 150 FB ...

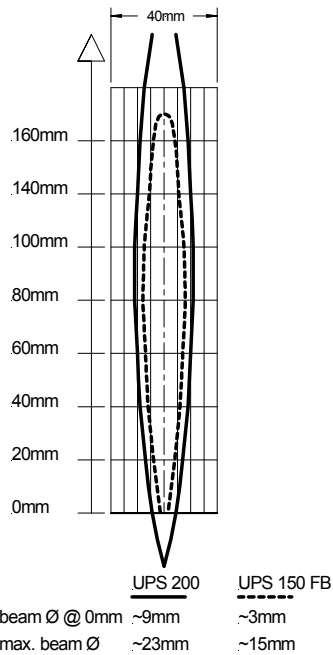
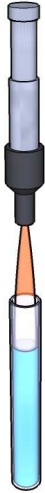

The ultrasonic sensors series UPS FB (FOCUS Beam) are equipped with a focusing device made of glass-fibre reinforced polypropylene, which makes the sound beam particularly narrow. Therefore they are suitable in the near range from 0mm up to 150mm to watch into narrow cavities. A typical application is measuring of liquid level in small tubes or containers.

With little distance between sensor and tube and, depending on the measuring height, levels can be measured in tubes which have only a few mm diameter. In very narrow setups, only a test can verify the feasibility of measurement.

UPS 150 CP ...

The diaphragm of the series UPS 150 CP (Chemical Protection) is coated with a thin PTFE foil. The head made of chemically resistant PVDF serves as mechanical fixation for the foil and protection of the sensor front part. Thus the front part of the ultrasonic sensor becomes resistant to most chemicals.

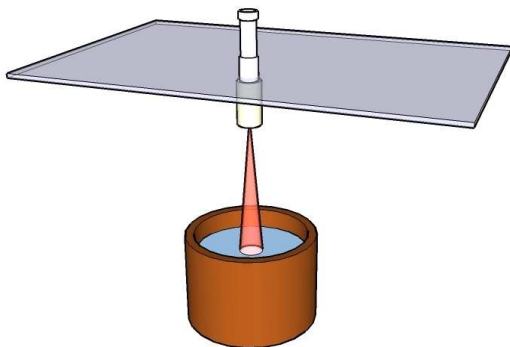

Dimensions

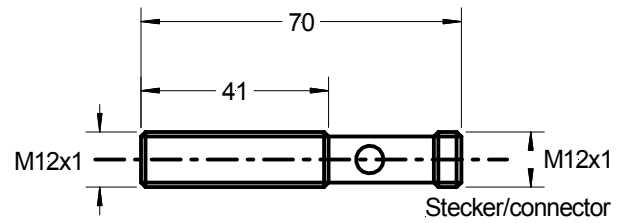

UPS 200 ...

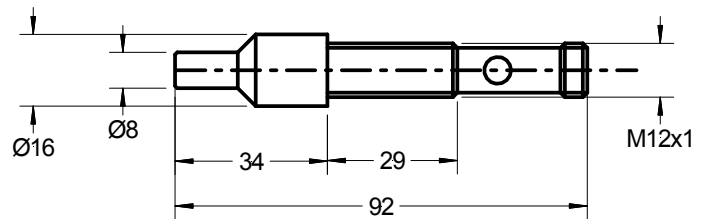

UPS 150 FB ...

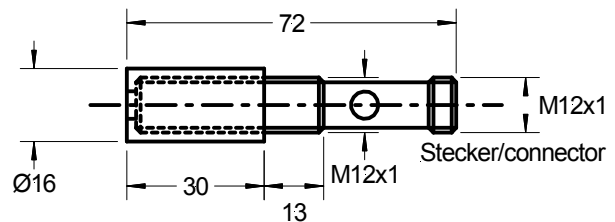

UPS 150 CP ...

Scope of delivery

- Sensor
- 2 M12 nuts

Accessories (see also data sheet ,ACC')

PUR cable 3-wire (pin 1, 3, 4) with M12 connector:
l=2m Type KAB 2L3VGPUR

PUR cable 4-wire with M12 connector:
l=2m Type KAB 2L4VGPUR

Teach-In box: see separate data sheet

SONARANGE

UPS 5.11 e

Detection beam

The detection beam of an ultrasonic sensor has the shape of a cone. The size depends on the target and its sound reflecting characteristics. Small and more badly reflecting objects result in a smaller cone (narrower and shorter). Bigger objects and those with surfaces which are not perpendicular to the central axis can expand the cone. The exact cone shape and size can be determined only at the

object itself. No disturbing objects must be between the sensor and the target within the cone. Otherwise the sensor would detect the disturbing object instead of the desired target. Below the typical cone shapes for the UPS sensors are shown. Furthermore the size of the detection beam is influenced by air temperature and humidity. The colder and dryer the air, the larger is the beam.

